

P R I C E L I S T

JANUARY 2009

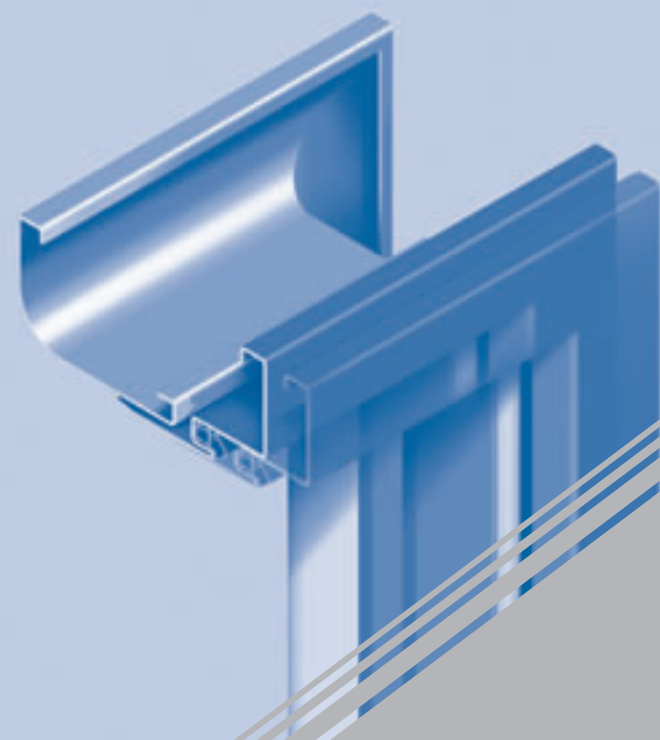

STAINLESS STEEL

- AISI 316 Stainless Steel is the stainless steel recommended for coastal areas or for especially contaminated areas (e.g. swimming pools with abundant chlorine).
- AISI 304 Stainless Steel is affected by a number of cleaning products.
- Some of them even affect AISI 316 Stainless Steel.
- Standard detergents or cleaning liquids that do not contain chlorine or abrasive components can be used.
- Do not expose the stainless steel to bleach or bleaching soda, given their corrosive closing force (if used in high concentrations), hard water or salt water. If exposed, wash with abundant water and dry the surface with a smooth cloth.
- In the case of persistent stains, use a bit of hot white vinegar.
- We recommend the use of brushes or sponges with nylon fibres.
- Do not use metallic scourers.

HPL COMPACT

- Very easy to clean.
- We recommend using a clean, damp and non-abrasive cotton cloth together with a mild detergent or cleaning agent used for house cleaning.
- In the case of difficult stains, clean the area with a mixture of one part of baking soda and water. The paste will be slightly abrasive, therefore, do not scrub.
- Do not use metal wool or other abrasive elements.
- Read the warnings and follow the instructions indicated on the labels of the cleaning products.

	PAGE
DOORS	
• FRAMES	
• TYPE SE - STAINLESS STEEL	4
• TYPE SD – ALUMINIUM	4
• TYPE SB - GALVANIZED STEEL	4
• TYPE SA – STEEL	5
• LEAVES	
• HPL COMPACT	6
• HPL	7-9
• SKIRTING BOARDS	9
• HARDWARE FITTINGS	
• • HANDLES. HINGES. ACCESSORIES.	
- AISI 316 STAINLESS STEEL	12-13
- AISI 304 STAINLESS STEEL	14-19
• LOCKS & CYLINDERS. ACCESS CONTROL SYSTEMS.	20-22
• EXIT PANIC DEVICES.	23
• DOOR CLOSERS.	24-26
• ANTIFINGER-CATCHING SYSTEM	27
CUBICLES	
• HPL COMPACT MATERIAL	28-29
• HARDWARE FITTINGS (AISI 316/304)	30-33
HPL COMPACT FURNITURE	
• WORKTOPS.	34
• BENCHES.	34
• LOCKERS	34
INTERIOR LINING (PANNELLING)	
• HPL COMPACT MATERIAL	35
NON-MACHINED HPL COMPACT	
	36
CONDITIONS OF SALE	
	37

DIRECTION CRITERIA ACCORDING TO DIN STANDARDS

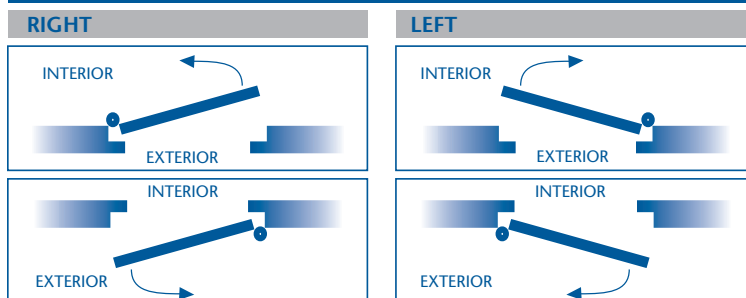

DOORS



HERRARKI



TYPE SE STAINLESS STEEL

Possibility of production in AISI 316

FRAMES

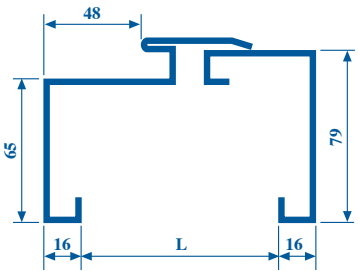
REFERENCE	DESCRIPTION	L WALL THICKNESS	FRAME TYPE (ANNEX 1)				
			1 A	1 B	2 A	2 B	
			*2190x1090	*2990x1090	*2190x1800	*2990x1800	
PRICE							
SE2 	HERRARKI brand telescopic metallic frame made of 1.2 mm thick AISI 304 stainless steel , with silent closing system by means of a rubber seal, provided in two pieces for installation after putting up walls. Ref. SE2.	101 - 150	985.63	1,182.76	1,379.88	1,577.01	
			150 - 200	1,232.04	1,478.45	1,724.86	1,971.26
			200 - 250	1,478.45	1,774.14	2,069.83	2,365.52

TYPE SD ALUMINIUM

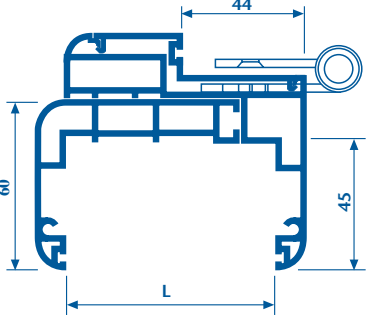
SD1 	Telescopic metallic frame made of 1.6 mm thick satin-finish silver aluminium with silent closing system by means of an extruded rubber seal. System designed for hidden hanging hardware fittings. HERRARKI brand for installation after putting up walls. Ref. SD1.	75 - 120	440.75	601.66	521.20	699.60
		120 - 165	542.19	709.73	633.14	815.03
		165 - 210	643.63	816.42	745.07	930.47
		210 - 255	745.07	924.49	857.01	1,045.91

TYPE SB GALVANIZED STEEL

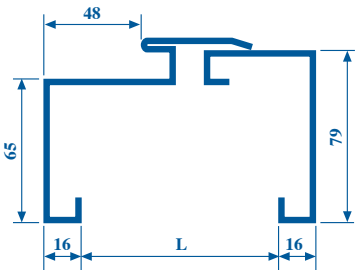
SB1 	HERRARKI brand telescopic metallic frame made of 1.5 mm thick galvanized steel , with silent closing system by means of a rubber seal, provided in two pieces for installation after putting up walls. Ref. SB1.	101 - 150	321.82	398.77	426.76	650.63
		150 - 200	514.21	591.16	615.65	843.02
		200 - 250	706.60	780.05	808.04	1,035.41

TYPE SA STEEL

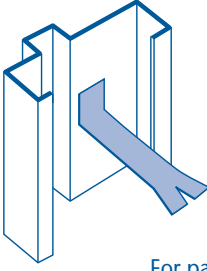
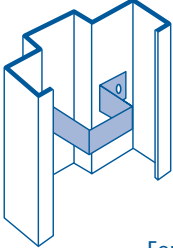
REFERENCE	DESCRIPTION	L WALL THICKNESS	FRAME TYPE (ANNEX 1)			
			1 A	1 B	2 A	2 B
			*2190x1090	*2990x1090	*2190x1800	*2990x1800
			PRICE			
 <p>For partition</p>	SA1 For partition Metallic frame of 1st class hot rolled steel. 15/10 thickness with 4 welded hinges or 2 V8600 crank type, pre-painted, polymerised in 180° furnace. HERRARKI brand, Ref. SA1. One piece to be installed while building the wall. Partition fitting.	100	136.74	369.20	169.04	456.40
		125	319.13	861.69	392.70	1,060.25
		150	230.29	621.83	268.16	724.03
		175	376.99	1,020.83	407.61	1,100.55
		200	286.09	772.41	336.94	909.74
		250	378.88	1,023.00	494.42	1,334.93
		300	406.24	1,096.87	521.71	1,408.59
 <p>For plasterboard</p>	SA3 For plasterboard Metallic frame of 1st class hot rolled steel. 15/10 thickness with 4 welded hinges or 2 V8600 crank type, pre-painted, polymerised in 180° furnace. HERRARKI brand, Ref. SA3. One piece to be installed while building the wall. Plasterboard fitting.	100	145.62	393.16	179.32	484.17
		125	369.12	996.62	482.16	1,301.84
		150	239.18	645.80	278.44	751.81
		175	428.08	1,155.77	497.10	1,342.13
		200	336.06	907.39	426.43	1,151.35
		250	428.87	1,157.93	583.89	1,576.52
		300	456.24	1,231.85	611.18	1,650.19

* UPPER HEIGHT: +8% / 100 mm
UPPER WIDTH: +4% / 100 mm

ORDERS OF LESS THAN:

- 10 UNITS, INCREASE BY 40%
- 25 UNITS, INCREASE BY 20%

DESCRIPTION	LEAF TYPE (ANNEX 1)			
	1 A	1 B	2 A	2 B
	*2190x1090	*2990x1090	*2190x1800	*2990x1800
	PRICE			
Leaf manufactured from phenolic HPL compact material using phenolic adhesive. 2.5 mm thick, each side. Plywood chassis and light chipboard interior. HPL Compact edge. HERRARKI brand.	510.33	850.55	1.150.37	1,830.82

DESCRIPTION	FRAME TYPE (ANNEX 1)			
	1 A	1 B	2 A	2 B
	*2190x1090	*2990x1090	*2190x1800	*2990x1800
	PRICE			
Leaf manufactured from phenolic HPL compact material using phenolic adhesive. 2.5 mm thick, each side. Plywood chassis and light chipboard interior. HPL Compact edge. HERRARKI brand. Lead Coated.	2,931.12	3,492.16	4,715.03	5,530.29

* UPPER HEIGHT: +8% / 100 mm
UPPER WIDTH: +4% / 100 mm

ORDERS OF LESS THAN:
• 10 UNITS, INCREASE BY 40%
• 25 UNITS, INCREASE BY 20%

DESCRIPTION	LEAF TYPE (ANNEX 1)			
	1 A	1 B	2 A	2 B
	*2190x1090	*2990x1090	*2190x1800	*2990x1800
	PRICE			
Solid chipboard leaf, 40 mm thick wooden perimeter frame, finished in high precision laminate material, Standard range. Wooden edge. HERRARKI brand.	372.68	721.16	875.07	1,486.43
BLOCK with 68x58 mm edge for painting and solid chipboard leaf, 40 mm thick wooden perimeter frame, finished in high precision laminate material, Standard range. Wooden edge. HERRARKI brand.	628.93	1,010.64	1,206.68	1,860.06

RF30 FIREBREAK

● Solid chipboard leaf, 40 mm thick wooden perimeter frame, finished in high precision laminate material, Standard range. Wooden edge. HERRARKI brand. RF30.	615.27	775.48	1,350.91	1,568.48
BLOCK with 68x58 mm edge for painting and solid chipboard leaf, 40 mm thick wooden perimeter frame, finished in high precision laminate material, Standard range. Wooden edge. HERRARKI brand. RF30.	909.90	1,139.30	1,777.31	2,112.67

RF60 FIREBREAK

● Solid chipboard leaf, 52 mm thick wooden perimeter frame, finished in high precision laminate material, Standard range. Wooden edge. HERRARKI brand. RF60.	931.70	1,214.00	2,148.94	2,576.96
BLOCK with 68x58 mm edge for painting and solid chipboard leaf, 52 mm thick wooden perimeter frame, finished in high precision laminate material, Standard range. Wooden edge. HERRARKI brand. RF60.	1,376.60	1,760.30	2,633.35	3,197.76

30 dB SOUND PROOF (without version 1B sound proof approval)

● Solid chipboard leaf, 40 mm thick wooden perimeter frame, finished in high precision laminate material, Standard range. Wooden edge. HERRARKI brand. 30dB SOUND PROOF.	688.24	892.87	-----	-----
BLOCK with 68x58 mm edge for painting and solid chipboard leaf, 40 mm thick wooden perimeter frame, finished in high precision laminate material, Standard range. Wooden edge. HERRARKI brand. 30dB SOUND PROOF.	1,024.61	1,307.32	-----	-----

35 dB SOUND PROOF

(without version 2B sound proof approval)

LEAF TYPE (ANNEX 1)			
1 A	1 B	2 A	2 B
*2190x1090	*2990x1090	*2190x1800	*2990x1800
PRICE			

DESCRIPTION	1 A	1 B	2 A	2 B
<ul style="list-style-type: none"> Solid chipboard leaf, 52 mm thick wooden perimeter frame, finished in high precision laminate material, Standard range. Wooden edge. HERRARKI brand. 35dB SOUND PROOF. 	-----	-----	2,061.36	2,431.40
<p>BLOCK with 68x58 mm edge for painting and solid chipboard leaf, 52 mm thick wooden perimeter frame, finished in high precision laminate material, Standard range. Wooden edge. HERRARKI brand. 35dB SOUND PROOF.</p>	-----	-----	2,526.55	2,804.48

38dB SOUND PROOF

without versions 1B/2B sound proof approval)

<ul style="list-style-type: none"> Solid chipboard leaf, 40 mm thick wooden perimeter frame, finished in high precision laminate material, Standard range. Wooden edge. HERRARKI brand. 38dB SOUND PROOF. 	976.97	1,243.50	2,213.93	2,616.60
<p>BLOCK with 68x58 mm edge for painting and solid chipboard leaf, 40 mm thick wooden perimeter frame, finished in high precision laminate material, Standard range. Wooden edge. HERRARKI brand. 38dB SOUND PROOF.</p>	1,426.21	1,794.98	2,375.22	2,845.10

- TO COMBINE WITH SA1/SA3 METALLIC FRAME

LEAD COATED

<p>Solid chipboard leaf, 40 mm thick wooden perimeter frame, finished in high precision laminate material, Standard range. Wooden edge. HERRARKI brand. LEAD COATED.</p>	2,139.50	2,549.02	3,441.63	4,036.71
<p>BLOCK with 68x58 mm edge for painting and solid chipboard leaf, 40 mm thick wooden perimeter frame, finished in high precision laminate material, Standard range. Wooden edge. HERRARKI brand. 38dB SOUND PROOF. LEAD COATED.</p>	3,350.22	4,023.95	4,385.08	5,199.85

SURCHARGE PER LEAF

<ul style="list-style-type: none"> STAINLESS STEEL PORTHOLE SET WITHOUT PANE. 	
AISI 304 Ø INTERIOR 225 REF. LI	176.00 euros
• WINDOW 400x300 installed	274.31 euros
• PORTHOLE Ø 300 or 400 installed	396.24 euros
• WINDOW 400x300 installed RF30	424.30 euros
• PORTHOLE Ø 400 installed RF30	881.51 euros
• WINDOW 400x300 installed RF60	848.93 euros
• PORTHOLE Ø 400 installed RF60	1,207.98 euros
• WINDOW 400x300 installed - for lead coated door.....	2,999.13 euros

* UPPER HEIGHT: +8% / 100 mm
UPPER WIDTH: +4% / 100 mm

ORDERS OF LESS THAN:
• 10 UNITS, INCREASE BY 40%
• 25 UNITS, INCREASE BY 20%

EDGES

- PVC 99.83 euros
-  AISI 304 STAINLESS STEEL 431.88 euros

MACHINED LEAF

..... 84.70 euros

DESCRIPTION	*300x1090 UNIT PRICE
1.2 mm thick AISI 304 stainless steel skirting board. HERRARKI brand. Not engraved.	80.71
1.2 mm thick AISI 304 stainless steel skirting board. HERRARKI brand. Engraved.	118.28

1A



1B



1C



1D



1E



1F



2A

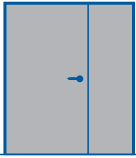

2B

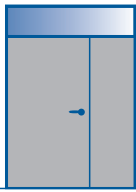

2C

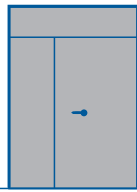

2D

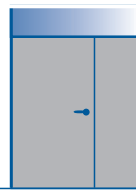

2E

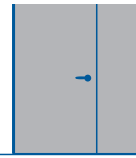

2F

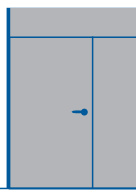

3A

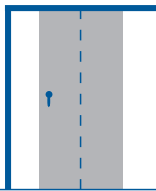

3B

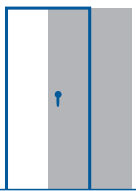

4A

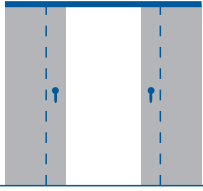

4B

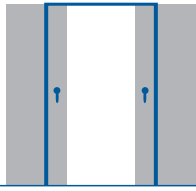

5A



6A



6B



6C



6D

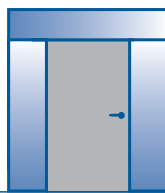

7A



7B

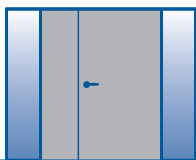

7C

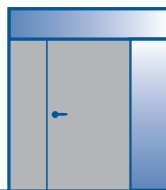

7D

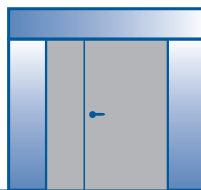

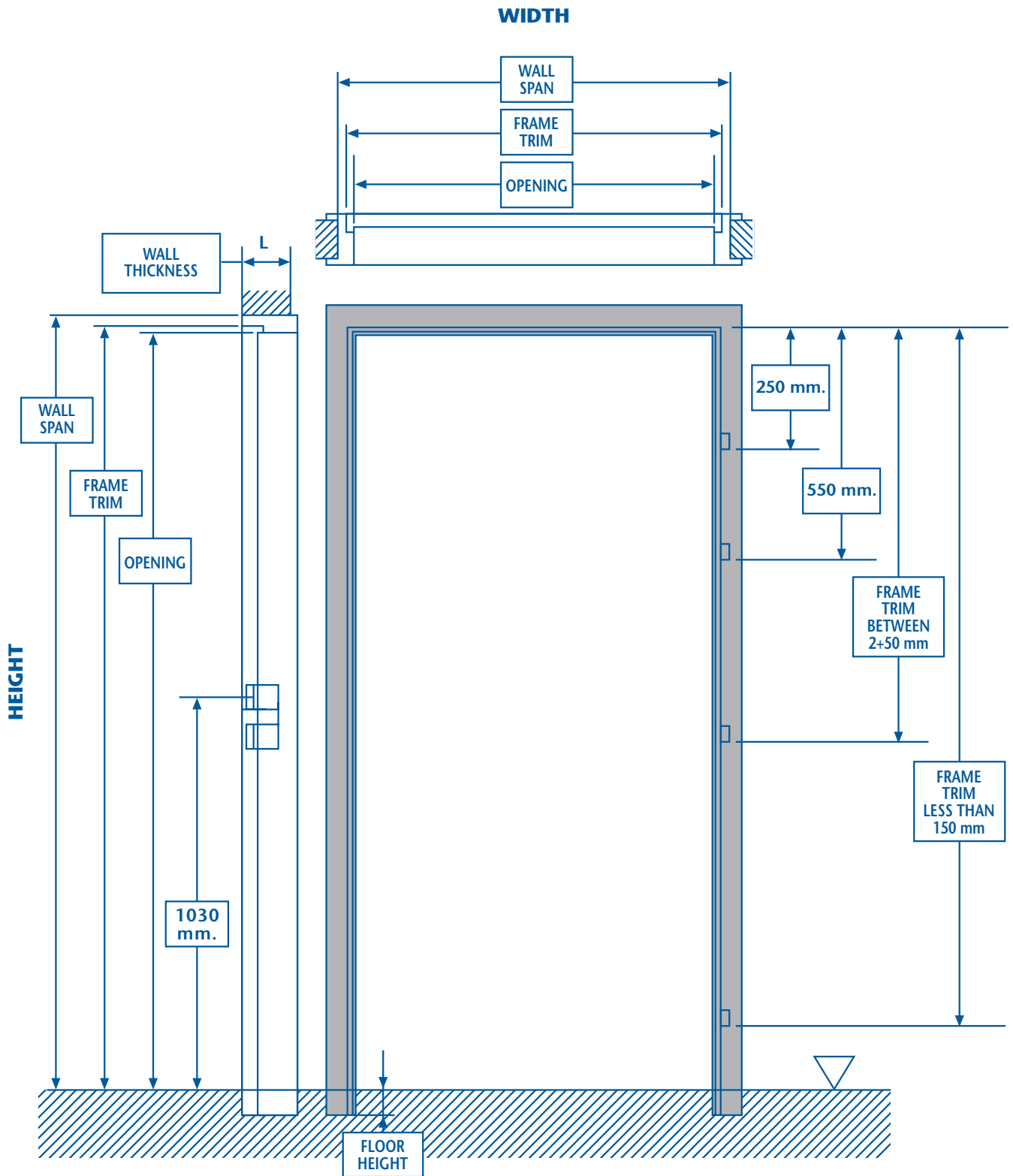

□ Overlap door









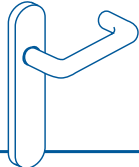
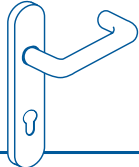

□ Straight edge door

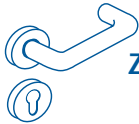





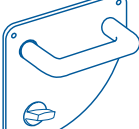



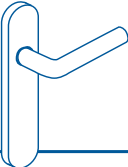
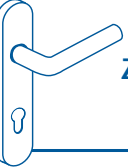
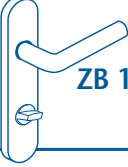

SATIN-FINISH
AISI 316
STAINLESS
STEEL

DOOR HANDLES

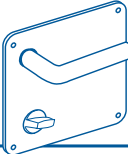
REFERENCE	DESCRIPTION	PRICE
 ZA 100 PLUS	Set of door handles, diameter 19 mm, with 226 x 43 mm metallic base , certified according to Standard UNE-EN 1906:2002, for transit doors Ref. ZA 100 PLUS, HERRARKI brand, supplied with return spring.	69.33
 ZA 100 PLUS-PZ	Set of door handles, diameter 19 mm, with 226 x 43 mm metallic base , certified according to Standard UNE-EN 1906:2002, for main doors Ref. ZA 100 PLUS-PZ, HERRARKI brand, supplied with return spring.	70.84
 ZA 100 PLUS-WC	Set of door handles, diameter 19 mm, with 226 x 43 mm metallic base , certified according to Standard UNE-EN 1906:2002, for bathroom doors with thumbturn and emergency button Ref. ZA 100 PLUS-WC, HERRARKI brand, supplied with return spring.	100.38
 ZA 200 PLUS	Set of door handles, with Ø 52 mm metallic base rosette, certified according to Standard UNE-EN 1906:2002, for transit doors Ref. ZA 200 PLUS, HERRARKI brand, supplied with return spring.	51.88
 ZA 200 PLUS-PZ	Set of door handles, with Ø 52 mm metallic base rosette, certified according to Standard UNE-EN 1906:2002, for main doors Ref. ZA 200 PLUS-PZ, HERRARKI brand, supplied with return spring.	65.77
 ZA 200 PLUS-WC	Set of door handles, with Ø 52 mm metallic base rosette, certified according to Standard UNE-EN 1906:2002, for bathroom doors with thumbturn and emergency button Ref. ZA 200 PLUS-WC, HERRARKI brand, supplied with return spring.	97.78
 ZA 300M PLUS	Set of door handles, diameter 19 mm, with 170x170 mm plate, certified according to Standard UNE-EN 1906:2002, for transit doors Ref. ZA 300M PLUS, HERRARKI brand, supplied with return spring.	75.09
 ZA 300M PLUS-PZ	Set of door handles, diameter 19 mm, with 170x170 mm plate, certified according to Standard UNE-EN 1906:2002, for main doors Ref. ZA 300M PLUS-PZ, HERRARKI brand, supplied with return spring.	76.60
 ZA 300M PLUS-WC	Set of door handles, diameter 19 mm, with 170x170 mm plate, certified according to Standard UNE-EN 1906:2002, for bathroom doors with thumbturn and emergency button Ref. ZA 300M PLUS-WC, HERRARKI brand, supplied with return spring.	106.14
 ZA 310 PLUS	Set of door handles with half-moon plate, certified according to Standard UNE-EN 1906:2002, for transit doors Ref. ZA 310 PLUS, HERRARKI brand, supplied with return spring.	110.47
 ZA 310 PLUS-PZ	Set of door handles with half-moon plate, certified according to Standard UNE-EN 1906:2002, for main doors Ref. ZA 310 PLUS-PZ, HERRARKI brand, supplied with return spring.	111.98
 ZA 310 PLUS-WC	Set of door handles with half-moon plate, certified according to Standard UNE-EN 1906:2002, for bathroom doors with thumbturn and emergency button Ref. ZA 310 PLUS-WC, HERRARKI brand, supplied with return spring.	141.52

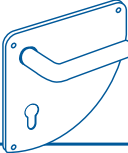







REFERENCE	DESCRIPTION	PRICE
 ZB 100 PLUS	Set of door handles, diameter 19 mm, with 226 x 43 mm metallic base , certified according to Standard UNE-EN 1906:2002, for transit doors Ref. ZB 100 PLUS, HERRARKI brand, supplied with return spring.	67.98
 ZB 100 PLUS-PZ	Set of door handles, diameter 19 mm, with 226 x 43 mm metallic base , certified according to Standard UNE-EN 1906:2002, for main doors Ref. ZB 100 PLUS-PZ, HERRARKI brand, supplied with return spring.	69.49
 ZB 100 PLUS-WC	Set of door handles, diameter 19 mm, with 226 x 43 mm metallic base , certified according to Standard UNE-EN 1906:2002, for bathroom doors with thumbturn and emergency button Ref. ZB 100 PLUS-WC, HERRARKI brand, supplied with return spring.	99.03
 ZB 200 PLUS	Set of door handles, with Ø 52 mm metallic base rosette, certified according to Standard UNE-EN 1906:2002, for transit doors Ref. ZB 200 PLUS, HERRARKI brand, supplied with return spring.	50.48
 ZB 200 PLUS-PZ	Set of door handles, with Ø 52 mm metallic base rosette, certified according to Standard UNE-EN 1906:2002, for main doors Ref. ZB 200 PLUS-PZ, HERRARKI brand, supplied with return spring.	64.37
 ZB 200 PLUS-WC	Set of door handles, with 52 mm metallic base rosette, certified according to Standard UNE-EN 1906:2002, for bathroom doors with thumbturn and emergency button Ref. ZB 200 PLUS-WC, HERRARKI brand, supplied with return spring.	96.38
 ZB 300M PLUS	Set of door handles, diameter 19 mm, with 170x170 mm plate, certified according to Standard UNE-EN 1906:2002, for transit doors Ref. ZB 300M PLUS, HERRARKI brand, supplied with return spring.	73.70
 ZB 300M PLUS-PZ	Set of door handles, diameter 19 mm, with 170x170 mm plate, certified according to Standard UNE-EN 1906:2002, for main doors Ref. ZB 300M PLUS-PZ, HERRARKI brand, supplied with return spring.	75.21
 ZB 300M PLUS-WC	Set of door handles, diameter 19 mm, with 170x170 mm plate, certified according to Standard UNE-EN 1906:2002, for bathroom doors with thumbturn and emergency button Ref. ZB 300M PLUS-WC, HERRARKI brand, supplied with return spring.	104.75
 ZB 310 PLUS	Set of door handles with half-moon plate, certified according to Standard UNE-EN 1906:2002, for transit doors Ref. ZB 310 PLUS, HERRARKI brand, supplied with return spring.	109.11
 ZB 310 PLUS-PZ	Set of door handles with half-moon plate, certified according to Standard UNE-EN 1906:2002, for main doors Ref. ZB 310 PLUS, HERRARKI brand, supplied with return spring.	110.62
 ZB 310 PLUS-WC	Set of door handles with half-moon plate, certified according to Standard UNE-EN 1906:2002, for bathroom doors with thumbturn and emergency button Ref. ZB 310 PLUS-WC, HERRARKI brand, supplied with return spring.	140.16

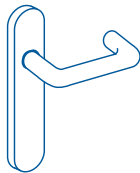
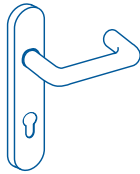
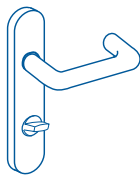





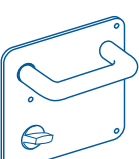

SATIN-FINISH
AISI 304
STAINLESS
STEEL

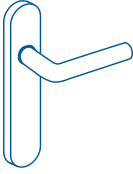
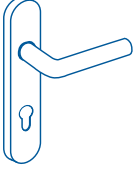
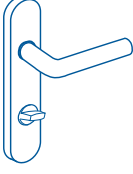

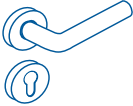
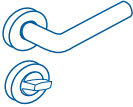
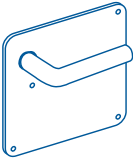

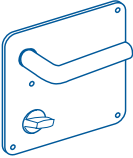
DOOR HANDLES

REFERENCE	DESCRIPTION	PRICE
 <p>ZA 100</p>	Set of door handles, diameter 19 mm, with 226 x 43 mm metallic base , certified according to Standard UNE-EN 1906:2002, for transit doors Ref. ZA 100, HERRARKI brand, supplied with return spring.	31.48
 <p>ZA 100-PZ</p>	Set of door handles, diameter 19 mm, with 226 x 43 mm metallic base , certified according to Standard UNE-EN 1906:2002, for main doors Ref. ZA 100-PZ, HERRARKI brand, supplied with return spring.	32.99
 <p>ZA 100-WC</p>	Set of door handles, diameter 19 mm, with 226 x 43 mm metallic base , certified according to Standard UNE-EN 1906:2002, for bathroom doors with thumbturn and emergency button Ref. ZA 100-WC, HERRARKI brand, supplied with return spring.	43.83
 <p>ZA 225</p>	Set of door handles, with Ø 52 mm metallic base rosette, certified according to Standard UNE-EN 1906:2002, for transit doors Ref. ZA 225, HERRARKI brand, supplied with return spring.	20.26
 <p>ZA 225-PZ</p>	Set of door handles, with Ø 52 mm metallic base rosette, certified according to Standard UNE-EN 1906:2002, for main doors Ref. ZA 225-PZ, HERRARKI brand, supplied with return spring.	30.01
 <p>ZA 225-WC</p>	Set of door handles, with Ø 52 mm metallic base rosette, certified according to Standard UNE-EN 1906:2002, for bathroom doors with thumbturn and emergency button Ref. ZA 225-WC, HERRARKI brand, supplied with return spring.	41.04
 <p>ZA 325</p>	Set of door handles, diameter 19 mm, with 180x180 mm plate, certified according to Standard UNE-EN 1906:2002, for transit doors Ref. ZA 325, HERRARKI brand, supplied with return spring.	37.35
 <p>ZA 325-PZ</p>	Set of door handles, diameter 19 mm, with 180x180 mm plate, certified according to Standard UNE-EN 1906:2002, for main doors Ref. ZA 325-PZ, HERRARKI brand, supplied with return spring.	38.86
 <p>ZA 325-WC</p>	Set of door handles, diameter 19 mm, with 180x180 mm plate, certified according to Standard UNE-EN 1906:2002, for bathroom doors with thumbturn and emergency button Ref. ZA 325-WC, HERRARKI brand, supplied with return spring.	49.70



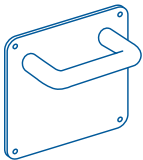

REFERENCE	DESCRIPTION	PRICE
 ZB 100	Set of door handles, diameter 19 mm, with 226 x 43 mm metallic base , certified according to Standard UNE-EN 1906:2002, for transit doors Ref. ZB 100, HERRARKI brand, supplied with return spring.	30.84
 ZB 100-PZ	Set of door handles, diameter 19 mm, with 226 x 43 mm metallic base , certified according to Standard UNE-EN 1906:2002, for main doors Ref. ZB 100-PZ, HERRARKI brand, supplied with return spring.	32.35
 ZB 100-WC	Set of door handles, diameter 19 mm, with 226 x 43 mm metallic base , certified according to Standard UNE-EN 1906:2002, for bathroom doors with thumbturn and emergency button Ref. ZB 100-WC, HERRARKI brand, supplied with return spring.	43.19
 ZB 225	Set of door handles, with Ø 52 mm metallic base rosette, certified according to Standard UNE-EN 1906:2002, for transit doors Ref. ZB 225, HERRARKI brand, supplied with return spring.	19.61
 ZB 225-PZ	Set of door handles, with Ø 52 mm metallic base rosette, certified according to Standard UNE-EN 1906:2002, for main doors Ref. ZB 225-PZ, HERRARKI brand, supplied with return spring.	29.36
 ZB 225-WC	Set of door handles, with Ø 52 mm metallic base rosette, certified according to Standard UNE-EN 1906:2002, for bathroom doors with thumbturn and emergency button Ref. ZB 225-WC, HERRARKI brand, supplied with return spring.	40.39
 ZB 325	Set of door handles, diameter 19 mm, with 180x180 mm plate, certified according to Standard UNE-EN 1906:2002, for transit doors Ref. ZB 325, HERRARKI brand, supplied with return spring.	36.73
 ZB 325-PZ	Set of door handles, diameter 19 mm, with 180x180 mm plate, certified according to Standard UNE-EN 1906:2002, for main doors Ref. ZB 325-PZ, HERRARKI brand, supplied with return spring.	38.24
 ZB 325-WC	Set of door handles, diameter 19 mm, with 180x180 mm plate, certified according to Standard UNE-EN 1906:2002, for bathroom doors with thumbturn and emergency button Ref. ZB 325-WC, HERRARKI brand, supplied with return spring.	49.08
 ZB 400	Window handle, 19 mm diameter, 45° position, Ø 7 mm, Réf. ZB400, HERRARKI brand.	17.31

GRIP HANDLES

REFERENCE	DESCRIPTION	UNIT PRICE
 C 100	19 mm. diameter grip handle, with 230x43 mm protection plate, Ref C 100, HERRARKI brand.	17.85
 CL 200	19 mm. diameter grip handle, with Ø 45 mm. rosette and 200 mm. between fixing points, Ref. CL 200, HERRARKI brand.	17.86
 C 325	19 mm. diameter grip handle, with 180x180 mm protection plate, Ref C 325, HERRARKI brand..	18.14
 Y60	Fixed knob, 66 mm. diameter, with Ø 78 mm. rosette, Ref. Y60, HERRARKI brand.	15.57

DIFFERENT CLEANING PLATE SIZES ARE SUPPLIED ON ORDER

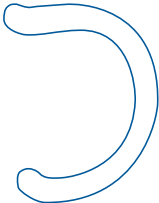
PULL HANDLES

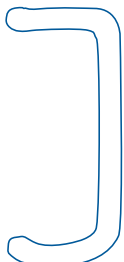
REFERENCE	DESCRIPTION	PRICE	
		SET	1/2 SET
 D 1	D1 - 200 Single piece pull handle, 30 mm. diameter and 200 mm. between fixing points, Ref. D1-200, HERRARKI brand.	381.98	190.99
	D1 - 300 Single piece pull handle, 35 mm. diameter and 300 mm. between fixing points, Ref. D1-300, HERRARKI brand.	432.92	216.46
 D 2	D2 - 250 Single piece pull handle, 30 mm. diameter and 250 mm. between fixing points, Ref. D2-250, HERRARKI brand.	259.74	129.87
	D2 - 350 Single piece pull handle, 35 mm. diameter and 350 mm. between fixing points, Ref. D2-350, HERRARKI brand.	313.22	156.61
 D 3	D3 - 250 Single piece pull handle, 30 mm. diameter and 250 mm. between fixing points, Ref. D3-250, HERRARKI brand.	364.14	182.07
	D3 - 350 Single piece pull handle, 35 mm. diameter and 350 mm. between fixing points, Ref. D3-350, HERRARKI brand.	417.64	208.82

CONSULT FACTORY FOR SPECIAL SIZES OR DESIGNS

SERIES D PULL HANDLE FIXING SYSTEM

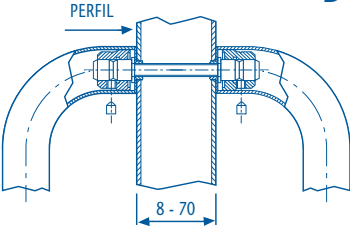
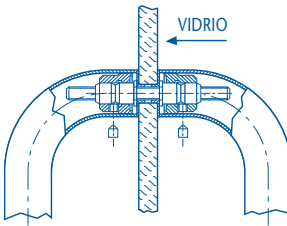
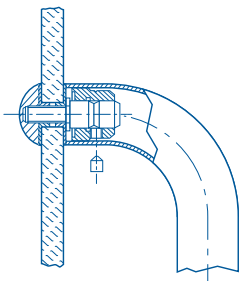
REFERENCE	DESCRIPTION	PRICE
 <p style="text-align: right;">D 201 I</p>	<p>D 201 I-30 Double fixing pin for set of 30 mm. stainless steel pull handles. Adjustment 8-70. Appropriate for wooden and metal carpentry or glass.</p>	37.84
	<p>D 201 I-35 Double fixing pin for set of 35 mm. stainless steel pull handles. Adjustment 8-70. Appropriate for wooden and metal carpentry or glass.</p>	39.13
 <p style="text-align: right;">D 207 I</p>	<p>D 207 I-30 Single fixing pin for half sets of 30 mm. stainless steel pull handles Appropriate for wooden and metal carpentry or glass. (*)</p>	28.73
	<p>D 207 I-35 Single fixing pin for half sets of 35 mm. stainless steel pull handles Appropriate for wooden and metal carpentry or glass. (*)</p>	30.00

* INDICATE DOOR THICKNESS

HINGES

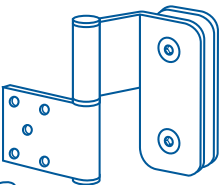
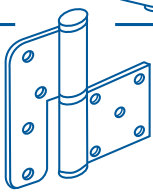
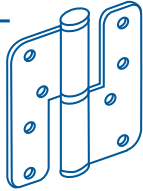
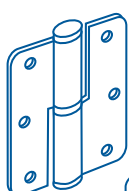
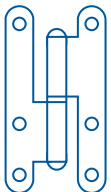
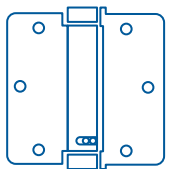
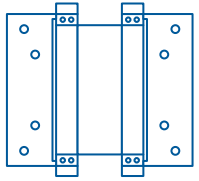
REFERENCE	DESCRIPTION	PRICE
 CR1	Satin-finish AISI 304 stainless steel hinge for glass door, Ref. CR1, HERRARKI brand.	29.36
 I 1010M	100x86 mm. AISI 304 stainless steel, satin-finish hinge, certified according to Standard UNE-EN 1935:2002, Ref. I 1086, HERRARKI brand.	6.83
 I 1086	100x86 mm. AISI 304 stainless steel, satin-finish hinge, certified according to Standard UNE-EN 1935:2002, Ref. I 1086, HERRARKI brand.	6.83
 I 9065	90x65 mm. AISI 304 stainless steel, satin-finish hinge, certified according to Standard UNE-EN 1935:2002, Ref. I 9065, HERRARKI brand.	3.50
 ZI 9552	95x54 mm. AISI 304 stainless steel, satin-finish hinge, certified according to Standard UNE-EN 1935:2002, Ref. ZI 9552, HERRARKI brand.	2.31
 I 1080	Single action 100x80x3 mm. AISI 304 stainless steel, satin-finished spring hinge, Ref. I 1080, HERRARKI brand. Includes fixing screws.	22.40
 I 125	Double action 125 mm. AISI 304 stainless steel, satin-finished spring hinge, Ref. I 125, HERRARKI brand.	23.02

COMPLETE BOXES SUPPLIED

CUPBOARD HANDLES

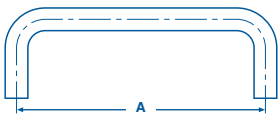
REFERENCE	DESCRIPTION	PRICE
 J	J 96	7.82
	J 128	9.15
	J 160	11.17
	J 192	12.73
	J 320	22.89
	J 416	28.80
	J 512	39.97

CUPBOARD KNOBS

REFERENCE	DESCRIPTION	PRICE
 <p>J 1</p>	Satin-finished, AISI 304. 25 mm stainless steel cupboard knob, Ref. J 1, HERRARKI brand.	6.33

DOOR STOP

REFERENCE	DESCRIPTION	PRICE
 <p>3743</p>	AISI 304 stainless steel door stop with rubber component, Ref. 3743, HERRARKI brand.	11.81

LATCH

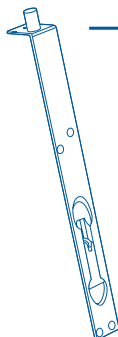
REFERENCE	DESCRIPTION	PRICE
 <p>3744</p>	Satin-finished, AISI 304 250 mm stainless steel latch, Ref. 3744, HERRARKI brand.	11.95

NOTES:

In order to calculate the price of half sets, divide the price of the set by two and add the price of the special square spindle

ACCESSORIES

REFERENCE	DESCRIPTION	PRICE
	Special square spindle for half sets. 8 x 70 mm.	5.91

We recommend the use of through bolts to install our door handles.

REFERENCE	DESCRIPTION	PRICE
	Nut and bolt set. m 4 x 60 mm.	0.68

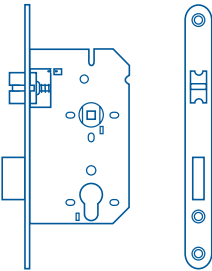
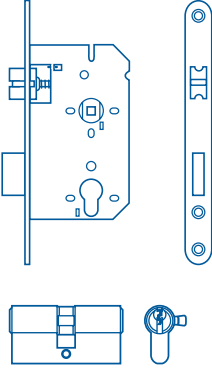
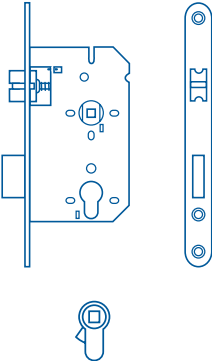
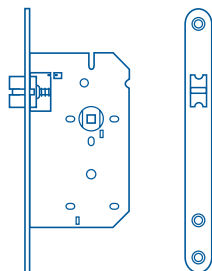
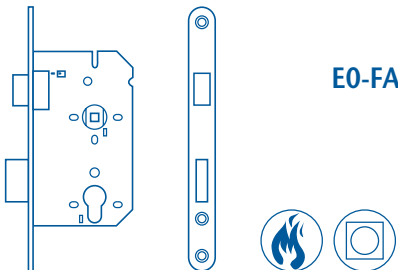
REFERENCE	DESCRIPTION	PRICE
 <p>E0-S</p>	<p>Mortice lock, HERRARKI brand, Ref. E0-S, for main door, standard European cylinder lock, with silent latch. Certificate according to Standard UNE-EN 12209:2004. Measurements according to German Standard DIN 18251</p> <p>Lacquered lock assembly. Reversible. Stainless steel front. Rounded edges. 60 mm. backset.</p>	19.56
 <p>E0-S-C</p>	<p>Mortice lock, HERRARKI brand, Ref. E0-S-C, for main door, standard European cylinder lock, with silent latch. Certificate according to Standard UNE-EN 12209:2004. Measurements according to German Standard DIN 18251</p> <p>Lacquered lock assembly. Reversible. Stainless steel front. Rounded edges. 60 mm. cylinder. Ref. F1</p>	28.16 (*)
 <p>E0-S-WC</p>	<p>Mortice lock, HERRARKI brand, Ref. E0-S-WC, for WC door, standard European cylinder lock, with silent latch. Certificate according to Standard UNE-EN 12209:2004. Measurements according to German Standard DIN 18251</p> <p>Lacquered lock assembly. Reversible. Stainless steel front. Rounded edges. 60 mm. cylinder. Cylinder-bath adapter.</p>	19.80
 <p>E2-S</p>	<p>Mortice lock, HERRARKI brand, Ref. E2-S, for transit door, standard European cylinder lock, with silent latch. Certificate according to Standard UNE-EN 12209:2004. Measurements according to German Standard DIN 18251</p> <p>Lacquered lock assembly. Reversible. Stainless steel front. Rounded edges. 60 mm. backset.</p>	14.89
 <p>E0-FA1</p>	<p>Fire-break and exit panic mortice locks with split follower, Ref. E0-FA1, for main door, standard European normalized lock cylinder. Class 3 based on German Standard Din 18250 Spring with excellent recovery capacity. Stainless steel front. Non-reversible.</p>	116.07

STANDARD SERIES

*(The latch cannot be opened by means of the cylinder.
Always installed with a set of door handles)*

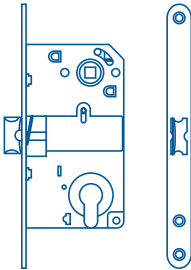
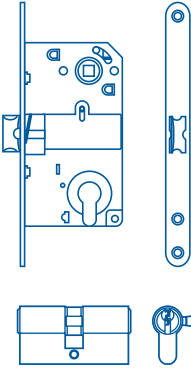
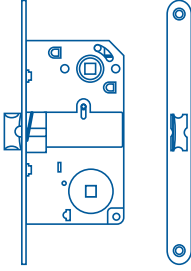
REFERENCE	DESCRIPTION	PRICE
 <p>E6</p>	<p>Mortice lock, HERRARKI brand. Ref. E6, for main door. Certificate according to Standard UNE-EN 12209:2004. Reversible Nickel-plated front. Rounded edges. 50 mm. backset.</p>	10.18
 <p>E6-C</p>	<p>Mortice lock, HERRARKI brand. Ref. E6-C, for main door. Certificate according to Standard UNE-EN 12209:2004. Reversible Nickel-plated front. Rounded edges. 50 mm. backset. 60 mm. cylinder. Ref. F1</p>	18.78 (*)
 <p>E6-WC</p>	<p>Mortice lock, HERRARKI brand. Ref. E6-WC, for transit/bathroom door. Certificate according to Standard UNE-EN 12209:2004. Reversible Nickel-plated front. Rounded edges. 50 mm. backset.</p>	10.77

SERIE GLASS

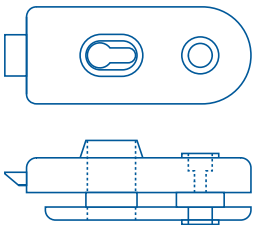
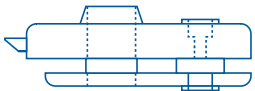
REFERENCE	DESCRIPTION	PRICE
 <p>CR0</p>	<p>Satin-finish Aisi 304 stainless steel lock for glass door, HERRARKI brand, Ref. CR0, for main door, with standard European lock cylinder. Reversible.</p>	35.84
 <p>CR0-C</p>	<p>Satin-finish Aisi 304 stainless steel lock for glass door, HERRARKI brand, Ref. CR0-C, for main door, with standard European lock cylinder. Reversible. 60 mm. cylinder. Ref. F1.</p> <p>HANDLES ADAPTED TO REF CR0: INOX PLUS SERIES INCREASE:</p> <ul style="list-style-type: none"> - SET OF ZA PLUS HANDLES - SET OF ZB PLUS HANDLES 	44.44
		20.21
		18.81

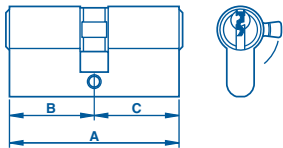
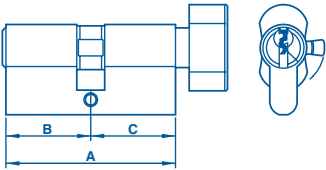
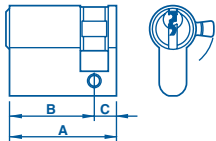
REFERENCE	DESCRIPTION	PRICE																														
		NICKEL-PLATED																														
<p style="text-align: center;">F1</p>  <p style="text-align: center;">Double cylinder.</p>	<p>Example of description text for Standard double cylinder, standard European profile, HERRARKI brand, Ref. F1 with five pins. Nickel-plated finish. 60 mm long. Based on mater-key study provided by the management.</p> <table border="1"> <thead> <tr> <th>Reference</th> <th>A (mm)</th> <th>B (mm)</th> <th>C (mm)</th> <th></th> </tr> </thead> <tbody> <tr> <td>F1030300</td> <td>60</td> <td>30</td> <td>30</td> <td>18.91</td> </tr> <tr> <td>F1035350</td> <td>70</td> <td>35</td> <td>35</td> <td>20.77</td> </tr> <tr> <td>F1030400</td> <td>70</td> <td>30</td> <td>40</td> <td>20.77</td> </tr> <tr> <td>F1040400</td> <td>80</td> <td>40</td> <td>40</td> <td>22.40</td> </tr> <tr> <td>F1030500</td> <td>80</td> <td>30</td> <td>50</td> <td>22.40</td> </tr> </tbody> </table>	Reference	A (mm)	B (mm)	C (mm)		F1030300	60	30	30	18.91	F1035350	70	35	35	20.77	F1030400	70	30	40	20.77	F1040400	80	40	40	22.40	F1030500	80	30	50	22.40	
	Reference	A (mm)	B (mm)	C (mm)																												
	F1030300	60	30	30	18.91																											
	F1035350	70	35	35	20.77																											
	F1030400	70	30	40	20.77																											
	F1040400	80	40	40	22.40																											
F1030500	80	30	50	22.40																												
<p style="text-align: center;">F1</p>  <p style="text-align: center;">Button cylinder.</p>	<table border="1"> <thead> <tr> <th>Reference</th> <th>A (mm)</th> <th>BxC (mm)</th> <th></th> </tr> </thead> <tbody> <tr> <td>F1235350</td> <td>70</td> <td>35 x 35</td> <td>24.85</td> </tr> </tbody> </table>	Reference	A (mm)	BxC (mm)		F1235350	70	35 x 35	24.85																							
	Reference	A (mm)	BxC (mm)																													
F1235350	70	35 x 35	24.85																													
<p style="text-align: center;">F1</p>  <p style="text-align: center;">Half cylinder.</p>	<table border="1"> <thead> <tr> <th>Reference</th> <th>BxC (mm)</th> <th></th> </tr> </thead> <tbody> <tr> <td>F1340100</td> <td>40 x 10</td> <td>16.68</td> </tr> </tbody> </table>	Reference	BxC (mm)		F1340100	40 x 10	16.68																									
	Reference	BxC (mm)																														
F1340100	40 x 10	16.68																														
MASTER-KEYING SURCHARGE	Simple master-keying	20.31																														
	Extensive master-keying	28.78																														
	Complicated master-keying under study	---																														
KEYS	Key blank	0.76																														
	Key copy	2.75																														
	Master key	5.59																														
	Additional key-aliked cylinders	2.89																														
SURCHARGES	Cylinder equal keys	4.96																														
	Cylinder to a specific key number	9.38																														

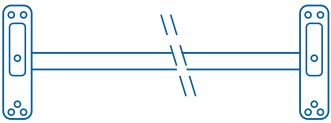
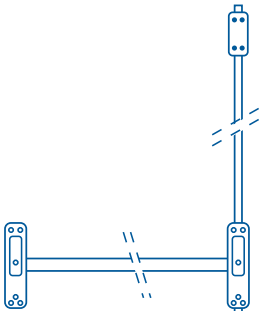
REFERENCE	DESCRIPTION	PRICE
 G210	Reversible exit panic device adaptable to mortice lock, with housing and lacquered steel bar, EC mark according to Standard UNE-EN 1125:1997, HERRARKI brand, Ref. G210.	149.69
G211	Reversible exit panic device adaptable to mortice lock, with matt nickel housing and stainless steel bar, EC mark according to Standard UNE-EN 1125:1997, HERRARKI brand, Ref. G211.	267.66
 G220	Reversible exit panic device with upper and lower latches, with housing, bar and lacquered steel bar cover, EC mark according to Standard UNE-EN 1125:1997, HERRARKI brand, Ref. G220.	206.67
G221	Reversible exit panic device with upper and lower latches, with matt nickel housing and stainless steel bar, EC mark according to Standard UNE-EN 1125:1997, HERRARKI brand, Ref. G221.	341.96

OTHER FINISHES AVAILABLE SUBJECT TO CONSULTATION

ACCESSORIES

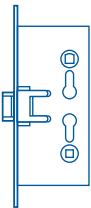

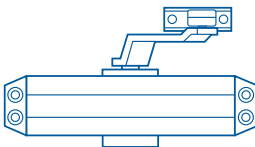
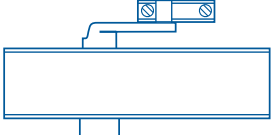
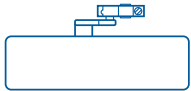
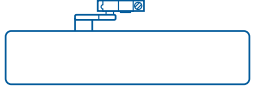
REFERENCE	DESCRIPTION	PRICE
 G2001	Fire-break lock and exit panic device with double split follower, Ref. G2001, \varnothing 9mm. Latch with key operated privacy lock.	46.70

REFERENCE	DESCRIPTION	PRICE
<p>H10</p> 	<p>Door closers with rack and pinion mechanism. HERRARKI brand, Ref. H1001, closing force 2-4 according to EN. Valve adjustable closing speed. Valve adjustable latch speed. Standard arm.</p>	60.94
	<p>Door closers with rack and pinion mechanism. HERRARKI brand, Ref. H1002, closing force 2-4 according to EN. Valve adjustable closing speed. Valve adjustable latch speed. Hold-open arm.</p>	99.06
<p>H11</p> 	<p>Door closers with rack and pinion mechanism. HERRARKI brand, Ref. H1101, closing force 1-5 according to EN, adjustable by position of the body. Valve adjustable closing speed. Valve adjustable latch speed. Firebreak based on French standards (Test 9540995 CSTB). Standard arm.</p>	101.56
	<p>Door closers with rack and pinion mechanism. HERRARKI brand, Ref. H1102, closing force 1-5 according to EN, adjustable by position of the body. Valve adjustable closing speed. Valve adjustable latch speed. Firebreak based on French standards (Test 9540995 CSTB). Hold-open arm.</p>	139.63
<p>H21</p> 	<p>Door closers with rack and pinion mechanism. HERRARKI brand, Ref. H2101, closing force 2-5 according to EN, adjustable by position of the body and arms. Valve adjustable closing speed. Arms adjustable latch speed. Firebreak based on French standards (Test 9540995 CSTB). Standard arm.</p>	133.39
	<p>Door closers with rack and pinion mechanism. HERRARKI brand, Ref. H2102, closing force 2-5 according to EN, adjustable by position of the body and arms. Valve adjustable closing speed. Arms adjustable latch speed. Hold-open arm.</p>	186.21
<p>H41</p> 	<p>Door closers with rack and pinion mechanism, HERRARKI brand, Ref H4101, closing force 1-6 based on UNE-EN 1154 A by adjusting closing force spring. Valve adjustable closing speed. Arms adjustable latch speed. Valve adjustable dampening when opening. Firebreak based on German DIN 18263 part 2. Standard arm.</p>	273.10
	<p>Door closers with rack and pinion mechanism, HERRARKI brand, Ref H4102, closing force 1-6 based on UNE-EN 1154 A by adjusting closing force spring. Valve adjustable closing speed. Arms adjustable latch speed. Valve adjustable dampening when opening. Hold-open arm.</p>	325.85

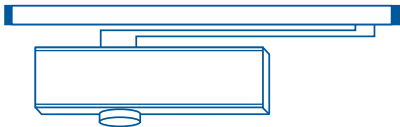



HOUSING + GUIDE RAIL

REFERENCE	DESCRIPTION	PRICE
 H12	Overhead rack and pinion door closer with guide rail, HERRARKI brand, Ref. H1201, closing force 3 according to UNE-EN 1154 A, adjustable by position. Valve adjustable closing speed. Valve adjustable latch speed. Firebreak based on French standards. (Test 9540995 CSTB).	149.59





HOUSING

REFERENCE	DESCRIPTION	PRICE
 H2500	Overhead rack and pinion door closer housing with guide rail, HERRARKI brand, Ref. H2500, closing force 1-3 according to EN by adjusting closing force spring. Valve adjustable closing speed. Valve adjustable latch speed. Firebreak based on French standards. (Test 9540995 CSTB).	189.35
 H5100	Overhead rack and pinion door closer housing with guide rail, HERRARKI brand, Ref. H5100, closing force 1-3 according to EN by adjusting closing force spring. Valve adjustable closing speed. Valve adjustable latch speed. Firebreak based on French standards. (Test 9540995 CSTB). * Surcharge for G assembly (for upper assembly on the side of the hinges or for normal assembly of the side opposite the hinges).	232.41 20.64
 H6100	Overhead rack and pinion door closer housing with guide rail, HERRARKI brand, Ref. H6100, closing force 2-6 (2-5) according to EN by adjusting closing force spring. Valve adjustable closing speed. Valve adjustable latch speed. Valve adjustable dampening when opening. Firebreak based on German DIN 18263 part 2. * Surcharge for closing delay (adjustable by valve). * Surcharge for G assembly (for upper assembly on the side of the hinges or for normal assembly of the side opposite the hinges).	332.22 62.56 20.64

GUIDE RAILS FOR SINGLE LEAF DOOR

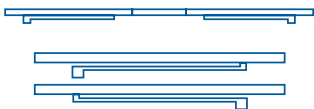
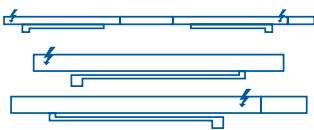
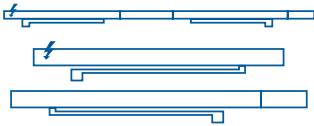
REFERENCE	DESCRIPTION	PRICE
 H0003	Standard guide rail.	64.57
 H0004	Guide rail with mechanical hold that can be disconnected (indicate side).	101.72
 H0005	Guide rail with electromagnetic hold (indicate side).	380.92
 H0006	Guide rail with electromagnetic hold and integrated smoke detector (indicate side).	1,413.73

GUIDE RAILS FOR DOUBLE LEAF DOORS

REFERENCE	DESCRIPTION	PRICE
 H0007	Guide rail with mechanical adjustment of closing mode (indicate side).	469.46
 H0008	Guide rail with mechanical adjustment of closing mode and two electromagnetic hold devices. Possibility of independent hold of either door leaf (indicate side).	1,657.17
 H0009	Guide rail with mechanical adjustment of closing mode and electromagnetic hold device on passive leaf. Hold on both leaves (indicate side).	1,132.95
 H0010	Guide rail with mechanical adjustment of closing mode and electromagnetic hold device on active leaf. Hold on active leaf only, no hold on passive leaf (indicate side).	1,132.95
	Ref. 01 A3 Ref. 01 A3 Kit of accessories for door widths 2735 mm – 3738 mm* (for guide Ref. H0007)	291.90
	Ref. 01 B3 Ref. 01 A3 Kit of accessories for door widths 2735 mm – 3738 mm * (other guide rail)	340,37
 0251	Smoke detector integrated in guide rails. Ref. H0008, H0009, H0010.	1,032.81
0252	Ceiling installation smoke detector.	351.75

* Distance measured from hinge to hinge. If the smoke detector is integrated in the guide rail, the measurement must be increased by 220 mm.

FINISH

- AVAILABLE
- ▲ UNAVAILABLE
- ★ SPECIAL PRODUCTION

REFERENCE	SILVER	GOLD	BRONZE	WITE	BLACK	COLOUR	STAINLESS STEEL
H-61	○	★	★	○	○	★	○
H-51	○	★	★	○	○	★	○
H-25	○	★	★	○	○	★	○
H-12	○	▲	○	○	▲	▲	▲
H-41	○	★	★	○	○	★	★
H-21	○	★	★	○	○	★	★
H-11	○	▲	○	○	▲	▲	▲
H-10	○	○	○	○	▲	▲	▲

STAINLESS STEEL SURCHARGE

(Only for door closers with guide rails).

	PRICE
Housing	132.01
Guide rail for single leaf door	88.00
Accessory kit	88.00
Guide rail for double leaf door (2 guide rails for one leaf + accessory kit).	263.99

ANTIFINGER-CATCHING SYSTEM

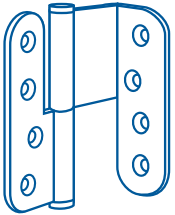
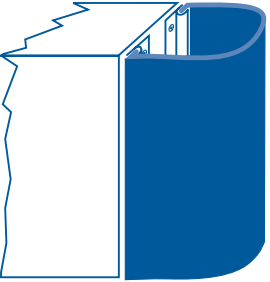
REFERENCE	DESCRIPTION	PRICE
 <p data-bbox="603 414 718 448">I 10 APD</p>	<p data-bbox="783 414 1268 492">Satin-finish AISI 304 stainless steel hinge with right-angle plate, Ref. I 10 APD, HERRARKI brand, antifinger-catching system.</p>	<p data-bbox="1380 414 1449 443">40.15</p>
 <p data-bbox="603 1097 718 1131">I 11 APD</p>	<p data-bbox="783 1097 1268 1176">1.50 metre profile fixing assembly and extruded rubber seal, HERRARKI brand, antifinger-catching system.</p>	<p data-bbox="1380 1097 1449 1126">37.05</p>

CUBICLES

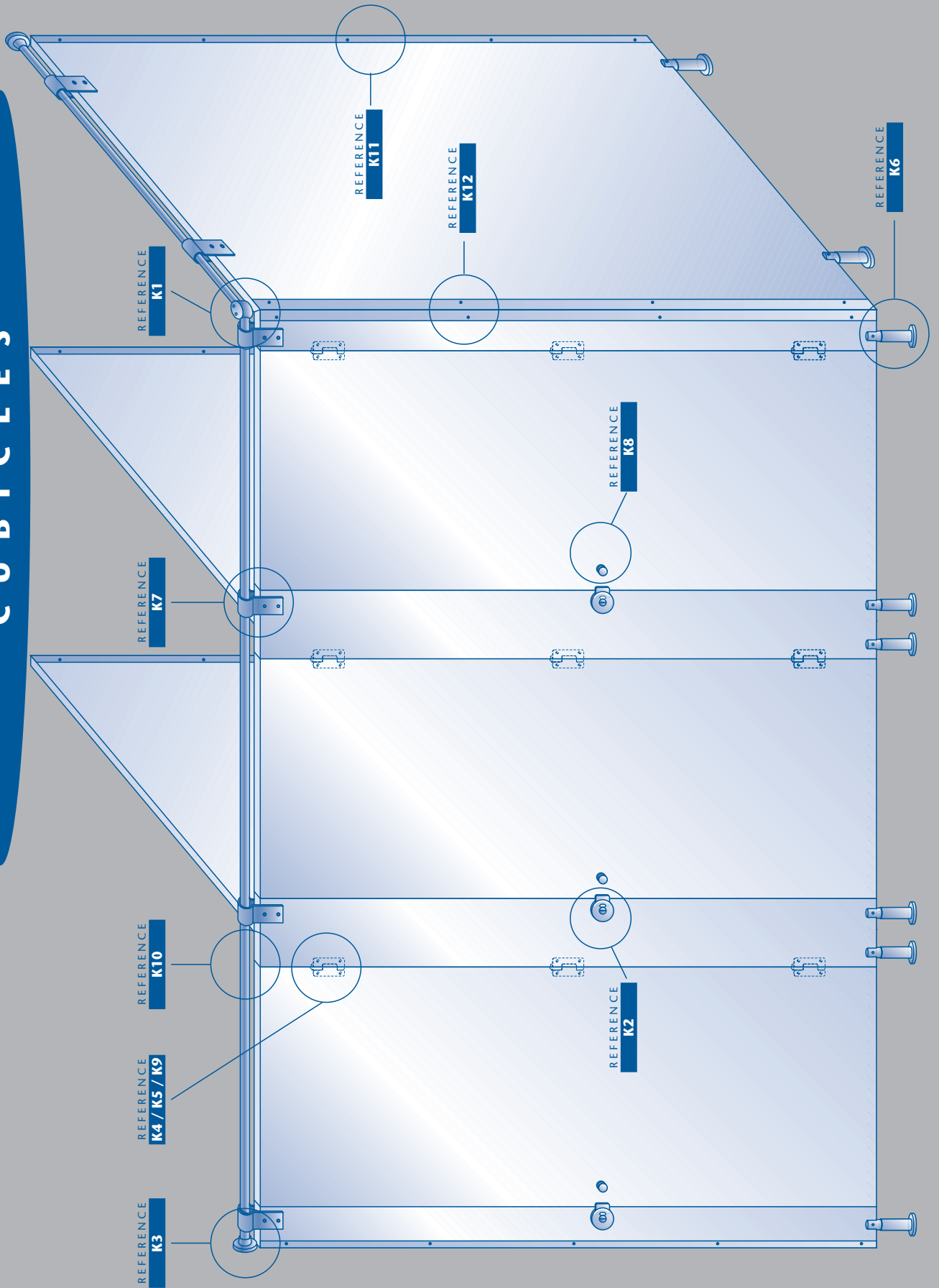

- SEND IN YOUR DRAWINGS AND WE WILL PREPARE A BUDGET.
- THE HPL COMPACT MATERIAL IS SUPPLIED DULY CUT AND MACHINED.
- WE WILL CALCULATE THE HARDWARE FITTINGS AND, IF YOU WISH, THE NUTS AND BOLTS.



SATIN-FINISH
AISI 316
STAINLESS
STEEL

HARDWARE FITTINGS FOR HPL COMPACT MATERIAL

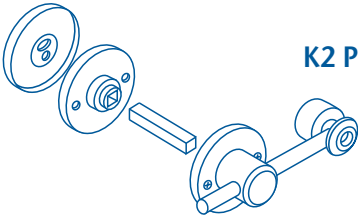
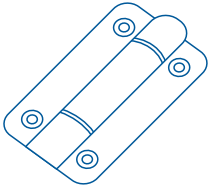
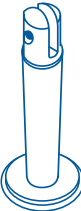
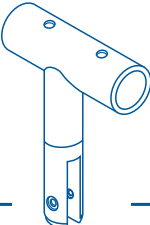
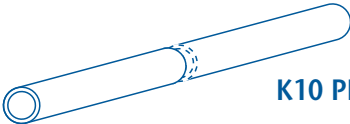
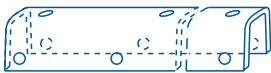
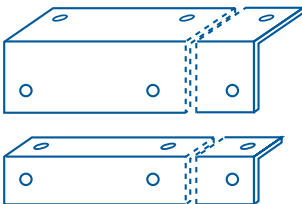
REFERENCE	DESCRIPTION	PRICE
 <p>K2 PLUS</p>	Thumbturn and emergency button, free-occupied indicator Ø50 mm. satin-finish AISI 316 stainless steel, Ref. K2 PLUS, HERRARKI brand.	29.68
 <p>K4 PLUS</p>	Flat hinge without spring, 90x52 mm, satin-finish AISI 316 stainless steel, Ref. K4 PLUS, HERRARKI brand.	17.88
 <p>K6 PLUS</p>	Adjustable leg in satin-finish AISI 316 stainless steel, Ref. K6 PLUS, HERRARKI brand.	40.57
 <p>K7 PLUS</p>	Satin-finish AISI 316 stainless steel CLAMP, Ref. K7 PLUS, HERRARKI brand.	24.70
 <p>K10 PLUS</p>	3 meter pipe, Ø 25 mm, machined, satin-finished AISI 316 stainless steel, Ref. K10 PLUS, HERRARKI brand.	140.87
 <p>K11 PLUS</p>	U shaped profile, 1,800 mm, satin-finished AISI 316 stainless steel, Ref. K11 PLUS, HERRARKI brand.	33.21
 <p>K12 PLUS</p>	Double corner profile, 1,800 mm, satin-finished AISI 316 stainless steel, Ref. K12 PLUS, HERRARKI brand.	55.09

NUTS AND BOLTS REQUIRED

			PRICE
HINGES (REF. K4 PLUS)	4 Screws DIN 7982 4.2 x 9.5	AISI 316 Stainless steel	0.17
U PROFILE (REF. K11 PLUS)	10 Screws DIN 7982 4.2 x 9.5	AISI 316 Stainless steel	0.17
DOUBLE CORNER PROFILE (REF. K12 PLUS)	16 Screws DIN 7981 4.2 x 9.5	AISI 316 Stainless steel	0.17
LEG CLAMP (REF. K7 PLUS)	22 Screws DIN 7991 M4 x 8 1 Sleeve M4 x 13 Ø 6 ext.l	AISI 316 Stainless steel Brass nickel	0.24 0.57





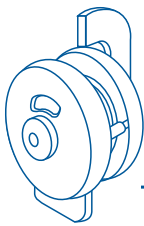
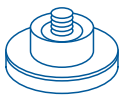
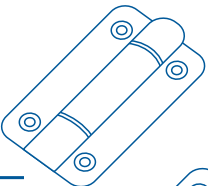
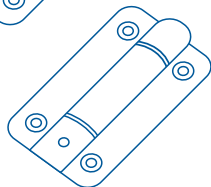
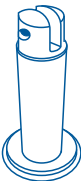
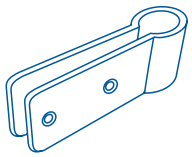
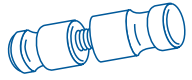
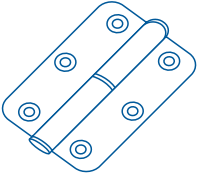
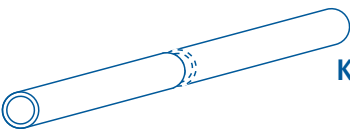
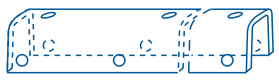

SATIN-FINISH
AISI 304
STAINLESS
STEEL

REFERENCE	DESCRIPTION	PRICE
 <p>K1/2 K1/3 K1/4</p>	<p>Knot corner Ø 45x45 mm (2/3/4 holes), satin-finished stainless steel - AISI 304, Ref. K1, HERRARKI brand.</p>	15.84
 <p>K2</p>	<p>Thumbturn and emergency button, free-occupied indicator Ø 64 mm, satin-finished stainless steel - AISI 304, Ref. K2, HERRARKI brand.</p>	25.65
 <p>K3</p>	<p>Pipe support assembly Ø 25 mm, wall fixing with trimming cover, Ø 64 mm, satin-finished stainless steel - AISI 304, Ref. K3, HERRARKI brand.</p>	13.55
 <p>K4</p>	<p>Flat hinge without spring - 90x52 mm, satin-finished stainless steel - AISI 304, Ref. K4, HERRARKI brand.</p>	7.74
 <p>K5</p>	<p>Flat hinge with spring - 90x52 mm, satin-finished stainless steel - AISI 304, Ref. K5, HERRARKI brand.</p>	11.62
 <p>K6</p>	<p>Adjustable support stand, satin-finished stainless steel - AISI 304, Ref. K6, HERRARKI brand.</p>	32.19
 <p>K7</p>	<p>Flat pincer tube, satin-finished stainless steel - AISI 304, Ref. K7, HERRARKI brand.</p>	16.94
 <p>K8</p>	<p>Double knob set Ø 25 mm, satin-finished stainless steel - AISI 304, Ref. K8, HERRARKI brand.</p>	19.36
 <p>K9</p>	<p>Flat hinge 81 x 75 mm, satin-finished stainless steel - AISI 304, Ref. K9, HERRARKI brand.</p>	4.11
 <p>K10</p>	<p>3 metre pipe, Ø 25 mm, machined, satin-finished stainless steel - AISI 304, Ref. K10, HERRARKI brand.</p>	70.74
 <p>K11</p>	<p>U profile - 1,800 mm, satin-finished stainless steel - AISI 304, Ref. K11, HERRARKI brand.</p>	29.37

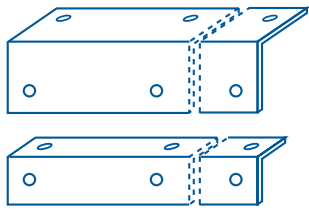
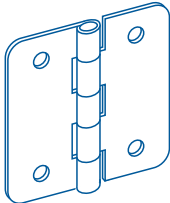
HARDWARE FITTINGS FOR HPL COMPACT MATERIAL

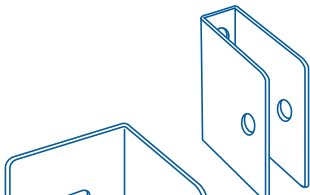
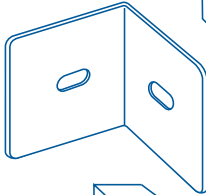
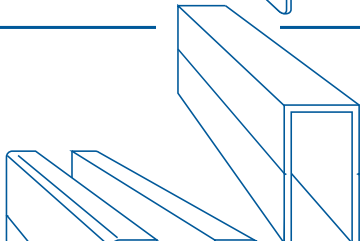
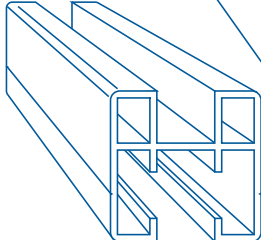
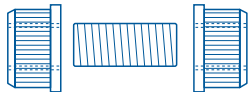
REFERENCE	DESCRIPTION	PRICE
 <p>K12</p>	Double profile corners -1,800 mm, satin-finished stainless steel - AISI 304, Ref. K12, HERRARKI brand.	46.42
 <p>K13</p>	Hinges for lockers - 63x63 mm, satin-finished stainless steel - AISI 304, Ref. K13, HERRARKI brand.	4.08
 <p>K14</p>	Hanger / wall-stop, satin-finished stainless steel - AISI 304, Ref. K14, HERRARKI brand.	12.27
 <p>K15</p>	Fixing clamp, satin-finished stainless steel - AISI 304, Ref. K15, HERRARKI brand.	2.57
 <p>K16</p>	Bracket, satin-finished stainless steel - AISI 304, Ref. K16, HERRARKI brand.	3.78
 <p>K17</p>	Silver-coloured aluminium U profile, Ref. K17, HERRARKI brand. (Price per meter. Supplied 2/3 meters).	9.75
 <p>K18</p>	Silver-coloured aluminium upper profile, Ref. K18, HERRARKI brand. (Price per meter. Supplied 2/3 meters).	20.13
 <p>K19</p>	Connection pipe 25, satin-finished stainless steel - AISI 304, Ref. K19, HERRARKI brand.	11.57

NUTS AND BOLTS REQUIRED

			PRICE
HINGES (REF. K4/K5)	4 Screws DIN 7982 4.2 x 9.5	Stainless steel	0.09
HINGE (REF. K9)	6 Screws DIN 7982 4.2 x 9.5	Stainless steel	0.09
U PROFILE (REF. K11)	10 Screws DIN 7981 4.2 x 9.5	Stainless steel	0.09
DOUBLE CORNER PROFILE(REF. K12)	16 Screws DIN 7981 4.2 x 9.5	Stainless steel	0.09
FLAT PINCER TUBE (REF. K7)	2 Screws DIN 7991 M4x8	Stainless steel	0.11
	2 Screws DIN 7991 M4x12	Stainless steel	0.12
	2 Sleeve M4x13 6 ext.	Brass nickel	0.57
SUPPORT STAND (REF. K6)	2 Screws DIN 7991 M4 x 12	Stainless steel	0.12
	1 Sleeve M4 x 13 Ø 6 ext.	Brass nickel	0.57
FIXING CLAMP (REF. K15)	2 Screws DIN 7982 4.2 x 9.5	Stainless steel	0.09



REFERENCE	DESCRIPTION	UNIT PRICE
K20	1 set of 2 buffers (K20 A), 2 support wheels (K20 B), 1 lower guide-rail (K20 C) and 1 thumbturn and emergency button (K20 D) manufactured in AISI 304 satin-finish stainless steel, REF. K20, HERRARKI brand.	265.00

WORKTOPS

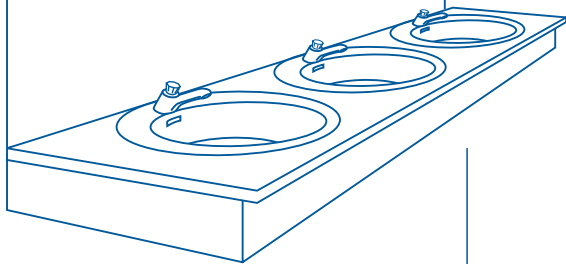

Phenolic HPL compact material worktop, 13 mm thick, fitted by means of stainless steel right-angle brackets. Standard width - 60 cm, skirting board 10 cm, flap -15 cm.

DESCRIPTION	PRICE
Price Euro/linear metre:	335.00
Enlargement of hole:	45.00
Stainless steel brackets, Euro/linear meter:	136.00

BENCHES

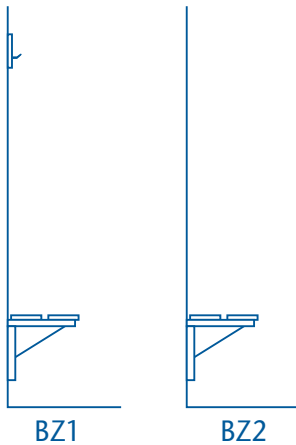

REFERENCE

DESCRIPTION

PRICE

Wall bench made of phenolic HPL compact material- 13 mm, with stainless steel structure.

BZ1	With hanger	1 meter	272.80
	With hanger	1.5 meters	410.40
	With hanger	2 meters	545.60
BZ2	Without hanger	1 meter	199.20
	Without hanger	1.5 meters	300.00
	Without hanger	2 meters	398.40

OTHER MODELS AVAILABLE SUBJECT TO CONSULTATION

LOCKERS

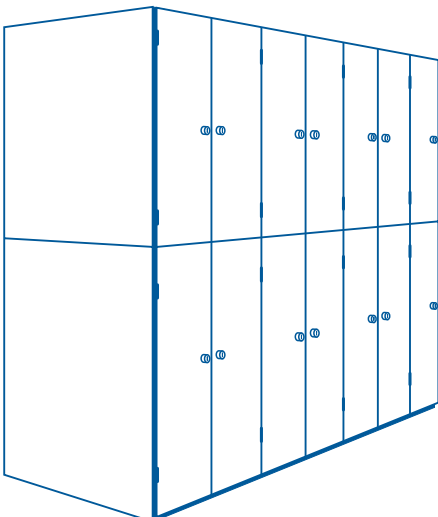

DESCRIPTION

PRICE

INITIAL 2 DOOR LOCKER

- Measurement of locker with support stand 180x30x50
- Doors made of phenolic HPL compact material - 13 mm thick
- White interior melamine board - 16 mm.
- Perforated rear board.

360.48

2 DOOR LOCKER EXTENSION

- Measurement of locker with support stand 180x30x50
- Doors made of phenolic HPL compact material - 13 mm thick
- White interior melamine board - 16 mm.
- Perforated rear board.

334.08

SIDE VISIBLE

128.00

POSSIBILITY OF SUPPLYING DIFFERENT LOCK MODELS

INTERIOR LINING



HPL COMPACT MATERIAL

- SEND IN YOUR DRAWINGS AND WE WILL PREPARE A BUDGET.
- THE PANNELS ARE SUPPLIED READY CUT BASED ON CUSTOMERS' INSTRUCTIONS

HERRARKI



	FORMAT	THICKNESS	PRICE €/m ²
DOORS	2130 / 1000	2.5	40.85 (1)
WALL LINING	3080 / 1250	6	71.19 (2)
CUBICLES	3660 / 1560	13	119.72 (1)

(1) STOCKED MEASUREMENTS FOR THE FOLLOWING SOLID COLOURS

HK - 203 YELLOW
 HK - 101 CREAM
 HK - 702 MERCURY GREY
 HK - 704 BLACK
 HK - 001 POLAR WHITE
 HK - 504 COBALT BLUE
 HK - 508 LAKE BLUE
 HK - 509 DALÍ BLUE
 HK - 401 RED
 HK - 402 BURGUNDY RED

(2) STOCKED MEASUREMENTS FOR THE FOLLOWING SOLID COLOURS

HK - 203 YELLOW
 HK - 702 MERCURY GREY
 HK - 001 POLAR WHITE

OTHER COLORS AND MEASUREMENTS, PLEASE CONSULT

- Estimated delivery time: 2/3 months
 - Minimum order: please consult

CONDITIONS OF TRANSPORT: POSSIBILITIES WILL BE EXPLORED

1. **PRICES EX-WORKS (EXW)**

2. CLAIMS

- a) All claims should be made in writing, indicating the reason for the claim, invoice num., bill number...
- b) Once the claim has been received, the commercial and/or technical department will proceed to study it and will provide an answer as soon as possible.
- c) No claims will be accepted beyond 15 days from the date the goods have left our warehouses.

3. RETURNED GOODS

- a) Returned goods must be preceded by a "request to return" made in writing, indicating the invoice num., bill num...
 - b) Once the request has been received, the commercial department will proceed to study it and will provide an answer as soon as possible. "Customised" products may not be returned.
 - c) If the request is accepted, payment will depend on the goods being in perfect selling conditions.
 - d) Transport will be paid by the customer.
4. The company reserves the right to change the technical specifications of the articles included in this price list without prior notice.

CONDITIONS OF SALE FOR "CUSTOMISED" PRODUCTS

- 1. All the orders for "customised" products must include a delivery date. Customers must approve the offer, including the delivery date.
- 2. Deadlines will always be considered valid once all technical specifications have been clarified and confirmed in writing.
- 3. Changes to an order being processed may lead to a new delivery date and to an increase in the price.

The logo for HERRARKI features the word "HERRARKI" in a bold, white, sans-serif font. The letters are contained within a dark blue horizontal oval. This oval is positioned over a white circular shape. Three parallel lines, two dark blue and one light grey, extend from the bottom left towards the top right, passing behind the white circle and the logo oval.

HERRARKI

HERRARKI, S.A.

Legutianoko Industrialdea • Polígono Gojain
c/ San Blas, 11 - Edificio D, bajo izda.
01171 LEGUTIANO - ALAVA - SPAIN
☎ +34 945 46 59 56 • FAX + 34 945 46 59 37



E-MAIL: info@herrarki.com
www.herrarki.com